







LG Chem
ESS Battery Division



 **Green
Engineering**
free energy to you

2016.04.22



Summary

Product	LV			HV	
	RESU 3.3	RESU 6.5	RESU 10	RESU 7H	RESU 10H
					
Australia	○	○	◎	○	◎
Germany	○	◎	○	○	○
U.S		○	○	○	◎

Product	RESU 6.4EX Main Pack	RESU 6.4EX Expansion Pack
Key Features <ul style="list-style-type: none"> ▶ Compactness & Lightness : World Best Energy Density ▶ Expandable : Up to 2 packs ▶ Strong Performance 		
Nominal Characteristics		
Total Energy	6.4 kWh	3.2 kWh
Battery Voltage (Range)	51.8 V DC (45.2~58.1V DC)	
Capacity	126 Ah	63 Ah
Physical Characteristics		
Dimension (W x H x D)	406 x 664 x 165mm	230 x 664 x 165mm
Weight	60 kg	30 kg
Energy Density	144 Wh/ℓ	127 Wh/ℓ
IP rating	21	
Electrical Characteristics		
Configuration	14S4P	14S2P
Charge/Discharge Power	3.3kW(Max Continuous)	3.3kW(Max Continuous)
Operating Conditions		
Communication	CAN, CANopen	
Operation Temperature	-30 ~ 50°C (0~40°C without Derating of Power)	

Product	RESU 3.3	RESU 6.5	RESU 10
Key Features <ul style="list-style-type: none"> ▶ Compactness : World Best Energy Density ▶ Expandable : Up to 2 packs ▶ Flexible installation : Wall mounted or Stand : Indoor or Outdoor : Diverse Inverter Matching 			
Nominal Characteristics			
Total Energy	3.3 kWh	6.5 kWh	9.8 kWh
Battery Voltage (Range)	51.8 V DC (42~58.8V DC)		
Capacity	63 Ah	126 Ah	189 Ah
Physical Characteristics			
Dimension (W x H x D)	452 x 401 x 120mm	452 x 654 x 120mm	452 x 482.5 x 227mm
Weight	31 kg	58 kg	75 kg
Energy Density	152 Wh/ℓ	183 Wh/ℓ	202 Wh/ℓ
IP rating	54		
Electrical Characteristics			
Configuration	14S1P	14S2P	14S3P
Charge/Discharge Power	3kW(Max Continuous)	4.2kW(Max Continuous)	5kW(Max Continuous)
Operating Conditions			
Communication	CAN		
Operation Temperature	-10~45°C (0~40°C without Derating of Power)		

With RESU Plus, customer has diverse options for expanding his/her RESU system. All Low Voltage products from the new RESU Series can be "cross-connected" with each other, providing a variety of choices.

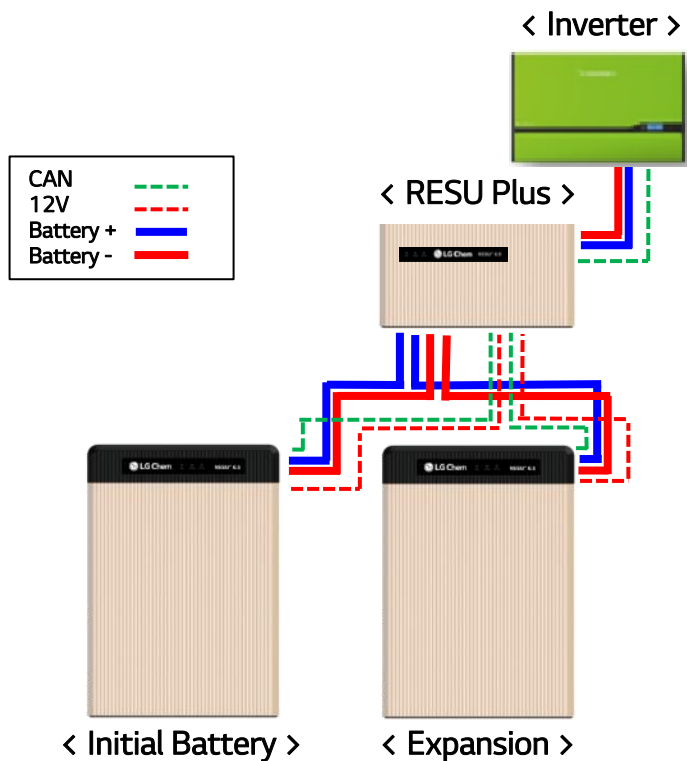

Expansion Concept





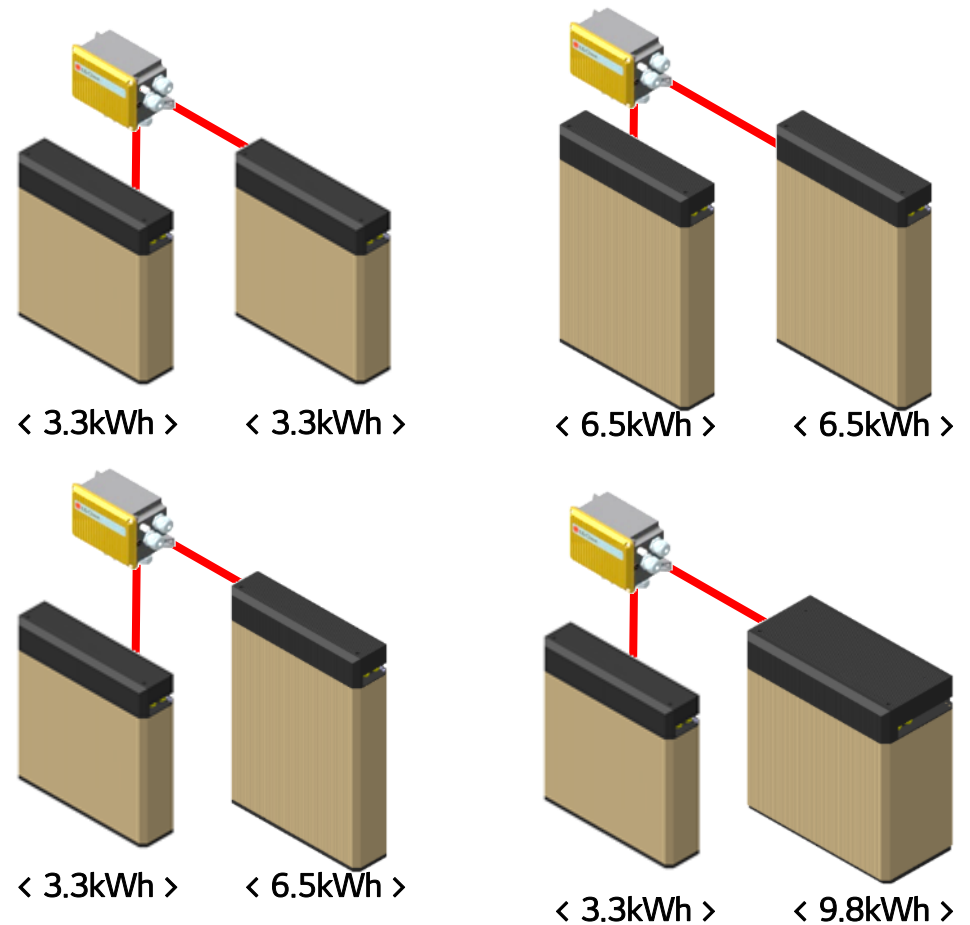

※ Expandable Up to 2 packs

Example of Combination (Max Continuous 5kW)











Product	RESU 7H	RESU 10H
Key Features <ul style="list-style-type: none"> ▶ Compactness : World Best Energy Density ▶ No Additional Devices : Aux Power and Protection Devices Included ▶ Flexible installation : Indoor or Outdoor : Diverse Inverter Matching 		
Nominal Characteristics		
Total Energy	7.0 kWh	9.8 kWh
Battery Voltage (Range)	350~450V DC	350~450V DC / 430~520V
Capacity	63 Ah	63 Ah
Physical Characteristics		
Dimension (W x H x D)	743 x 692 x 205	743 x 907 x 205
Weight	85 kg	95 kg
Energy Density	66 Wh/ℓ	71 Wh/ℓ
IP rating	54	
Electrical Characteristics		
Configuration	30S1P	42S1P
Charge/Discharge Power	3.5kW (Max Continuous)	5kW (Max Continuous)
Operating Conditions		
Communication	CAN / RS485	CAN / RS485
Operation Temperature	-10~45°C (0~40°C without Derating of Power)	

LG Chem has already matched RESU 6.4EX with various global top-tier inverters including low price inverters

Battery Model		RESU 6.4EX											
Inverter Maker		SMA			Sungrow	Nedap		SolaX			Goodwe/Redback		
Model		Sunny Island			SH 5K	PowerRouter		X-Hybrid			ES-series		
Appearance													
Spec.	Type	Battery Inverter			Hybrid	Hybrid		Hybrid			Hybrid		
	Max. Power (kW)	4.4 (30min)	6 (30min)	5.3 (30min)	5	3.7	4.6	3.3	3.68	5	3.6	4.6	
	Nom. Power(kW)	3.3	4.6	4.5	5	3.68	5	3	3.68	4.6	2.3	4.6	
	Dimension (WxHxD, mm)	467x612x242			447x510x150		765x502x149		490x595x167			516x440x184	
	Weight(kg)	44	63	63	20	21.5		27.7			28	30	

※ More matching is under process such as Victron Energy and Schneider XW

Battery Model	RESU 3.3 / RESU 6.5 / RESU 10					
Inverter Maker	SMA	Sungrow	Nedap	SolaX	Goodwe/Redback	Ingeteam
Model	Sunny Island	SH 5K	PowerRouter	X-Hybrid	ES-series	Ingecon Sunstorage
Appearance						
Type	Battery Inverter	Hybrid Inverter	Hybrid Inverter	Hybrid Inverter	Hybrid Inverter	Hybrid Inverter
Target Market	Europe / Australia	Australia	Europe	Europe / Australia	Europe / Australia	Europe
Matching Status	'16. 2Q	'16. 2Q	'16. 2Q	'16. 2Q	'16. 2Q	'16. 2Q

Battery Model	RESU 10H	RESU 7H & 10H	RESU 7H&10H	RESU 7H & 10H
Inverter Maker	Delta	SolarEdge	SMA	Fronius
Model	Solarcity Exclusive	SE	AC couple high Voltage	Symo Hybrid
Appearance	N/A			
Type	Hybrid Inverter	Hybrid Inverter	Battery inverter	Hybrid Inverter
Target Market	U.S only	Europe / Australia/U.S	Europe / Australia/U.S	Europe / Australia/U.S
Matching Status	'16. 2Q	'16. 2Q	'16. 3Q	'16. 4Q

End of Document